

◇ MSOP10 Package Outline Dimensions

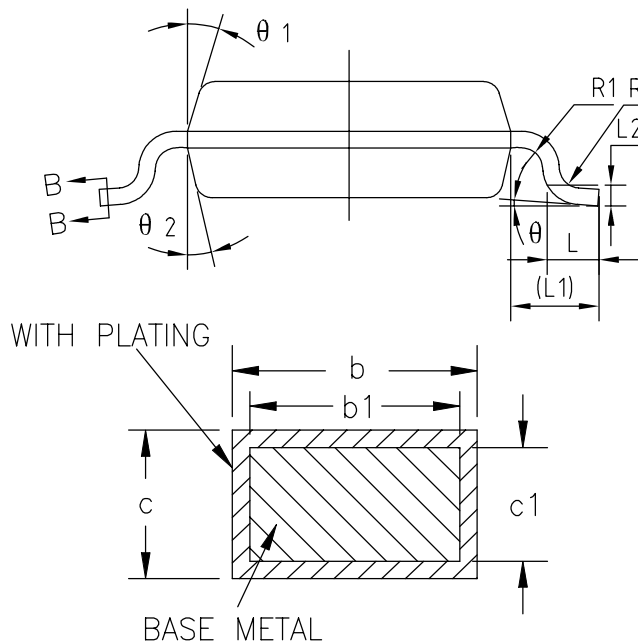
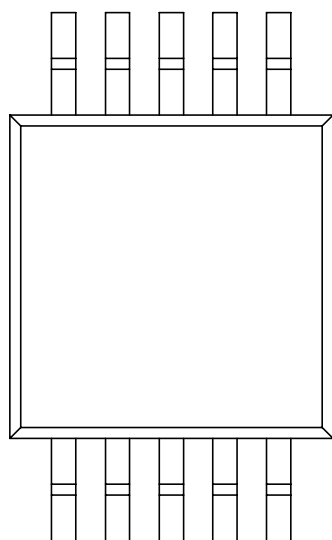
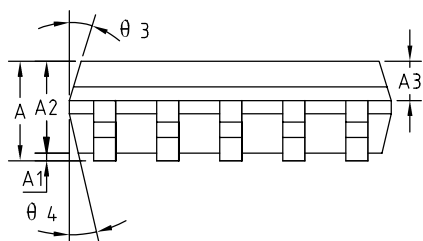
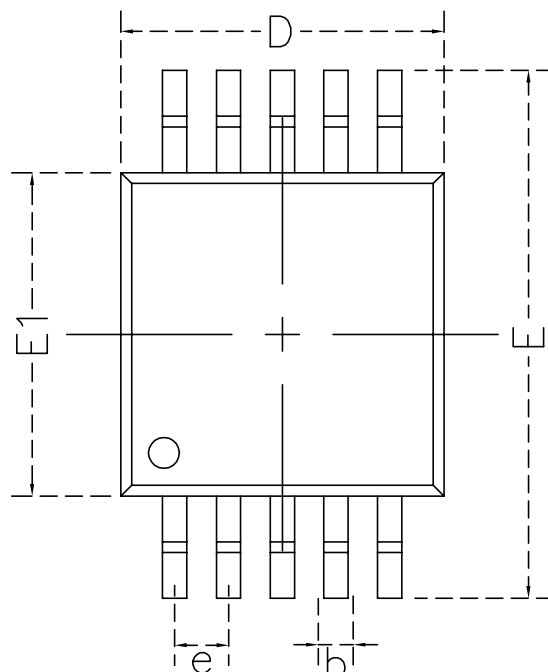

SYMBOL	MIN	NOM	MAX
A	—	—	1.10
A1	0	—	0.15
A2	0.75	0.85	0.95
A3	0.25	0.35	0.39
b	0.18	0.225	0.27
b1	0.17	0.20	0.23
c	0.154	0.177	0.20
c1	0.144	0.152	0.16
D	2.90	3.00	3.10
e	0.40	0.50	0.60
E	4.70	4.90	5.10
E1	2.90	3.00	3.10
L	0.40	0.60	0.80
L1	0.95REF		
L2	0.25BSC		
R	0.07	—	—
R1	0.07	—	—
θ	0°	—	8°
θ1	9°	12°	15°
θ2	9°	12°	15°
θ3	9°	12°	15°
θ4	9°	12°	15°

NOTES:

1. ALL DIMENSIONS REFER TO JEDEC STANDARD MO-137E
2. DIMENSION D DOES NOT INCLUDE MOLD FLASH
3. DIMENSION E1 DOES NOT INCLUDE MOLD FLASH
4. FLASH OR PROTRUSION SHALL NOT EXCEED 0.25mm PER SIDE.